

The Ruukki logo is displayed in white, uppercase letters on a red rectangular background in the top right corner of the image. The background of the entire page is a high-angle photograph of a house with a blue corrugated metal roof, a white exterior wall, and a window with light-colored curtains. The house is surrounded by green grass and some flowering plants in the foreground.

RUUKKI

# Ruukki katusetoodete hinnakiri

Kehtib alates 17.04.2026

Hinnad ei sisalda transporti



## SISUKORD

Katuste kvaliteediklassid .....	3	Ventilatsioonitorud ja läbiviigud .....	18
Katuseprofiilid .....	4	Vihmaveesüsteem Siba Tech .....	20
Classic-profiilide võrdlustabel .....	8	Vihmaveesüsteem, ümar .....	23
Katuseprofiilide värvitoonid .....	9	Vihmaveesüsteemi lisatarvikud .....	26
Lisaplekid Classic- ja Valtsprofiilidele .....	10	Vihmaveesüsteem, peidetud .....	27
Lisaplekid kivi- ja trapetsprofiilidele .....	13	Lumetõkked, katusesillad, redelid .....	30
Kruvid, tihendid, aluskatted, tarvikud, parandusvärvid .....	15		

## KATUSTE KVALITEEDIKLASSID

Katuse toodete vastupidavuse ja pikaajalisuse määravad toote kvaliteediklass ja materjali tehnilised omadused, mis on olulised nii katuse tootmis- kui paigaldusprotsessis ja samuti hilisemas eksploatatsioonis. Näiteks ultraviolettkiirguse (UV) taluvus tagab värvitooni säilimise, kriimustuskindlusest sõltub aga värvkatte eluiga. Ümbritseva keskkonnaklassist tuleneb vajalik korrosioonikindlus, mõjutavad keskkonna saastatus, agressiivsus, niiskus ja sadeveed.

Kui materjali kasutada vales keskkonnaklassis, on tagajärjeks katuse eluea vähenemine. Väga oluline näitaja on temperatuuritaluvus; põhjamaises kliimas kõigub temperatuur vahemikus -30 °C kuni +30 °C. Lisaks veel pinnakatte paksus ja struktuur, puhtana püsivus ehk hooldusvajadus, esteetiline ja tehniline garantii.

[www.ruukki.ee](http://www.ruukki.ee)



Kvaliteediklass	Ruukki® 50 Plus	Ruukki® 40	Ruukki® 30
UV-taluvus	■■■■■	■■■■□	■■■□□
Kriimustuskindlus	■■■■■	■■■■▣	■■■□□
Korrosioonikindlus	■■■■■	■■■■□	■■■□□
Tööeldavus	■■■■■	■■■□□	■■□□□
Keskkonnateadlik tootmine (GreenCoat® Bio-based Technology)	☑	□	□
Pinnaviimistlus	matt	matt	läikiv
Garantii (tehniline/esteetiline)	50/25 aastat	40/15 aastat	30/10 aastat



# KATUSEPROFIILID

Classic Silence

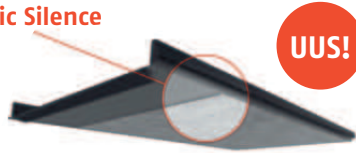

UUS!



Skaneeri kood ja vaata lisainfot Silence'i kohta!

## CLASSIC-PROFIILID

NB! Alla 20 m<sup>2</sup> tellimisel lisandub toote hinnale tootmise stardimaks 30 € (km-ta). Katuseprofiilid toodetakse igale kliendile eraldi vastavalt konkreetse katuse projektile. Kliendi spetsifikatsiooni alusel tellitud kaupa pole võimalik tagastada.

Hind €/m<sup>2</sup> 24% km-ga (€/m<sup>2</sup> km-ta)

Toote nimi	Ruukki® 50 Plus	Ruukki® 50 Plus Silence**	Ruukki® 40 matt	Ruukki® 40 Silence**
Classic Authentic C/M 0,6* SR35-475C/M	26,66 (21,50)	33,48 (27,00)		
Classic C/M 0,5* SR35-475C/M	22,32 (18,00)	29,14 (23,50)	20,21 (16,30)	27,03 (21,80)

NB! Vaata võrdlustabelit leheküljel 8

\* Classic-profiili saab tellida ülemise räästavaltsi valmidusega (AnySide), mis võimaldab paigaldada profiili vasakult paremale. Hinnale lisandub 0,50 €/m<sup>2</sup> + km.

\*\* Tänu tehases paigaldatud spetsiaalsele materjalile on Classic-katus kolmandiku võrra vaiksem.

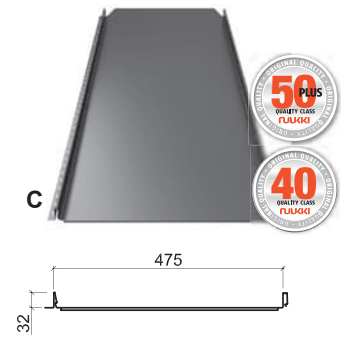
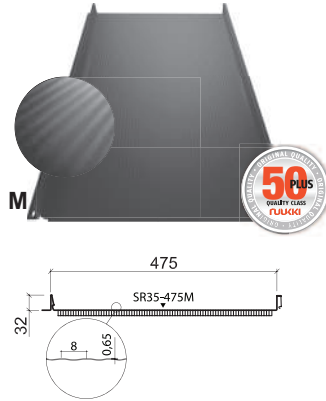

\*\*\* RR11 RR21 RR22 RR29 RR750

CLASSIC AUTHENTIC 0,6	
Profiili kõrgus	32 mm
Kasulik laius	475 mm
Profiili laius	510 mm
Max pikkus	12 500 mm
Min pikkus	1200 mm
Min kalle	8°
Materjali paksus	0,6 mm
Tsingikiht	275 g/m <sup>2</sup>
Kaal	6,2 kg/m <sup>2</sup>

- ✓ Tagasipainutatud räästaserv
- ✓ Tuisukork
- ✓ Mikroprofileering kinnituskohtades
- ✓ Lisatasu eest võimalik tellida ka AnySide
- ✓ Saadaval Silence-profiilina

CLASSIC M 0,6/0,5	
Profiili kõrgus	32 mm
Kasulik laius	475 mm
Profiili laius	510 mm
Max pikkus	12 500 mm
Min pikkus	1200 mm
Min kalle	8°
Materjali paksus	0,5/0,6 mm
Tsingikiht	275 g/m <sup>2</sup>
Kaal	5,2/6,2 kg/m <sup>2</sup>

- ✓ Tagasipainutatud räästaserv
- ✓ Tuisukork
- ✓ Mikroprofileering kinnituskohtades
- ✓ Lisatasu eest võimalik tellida ka AnySide
- ✓ Mikroprofileering profiilil
- ✓ Saadaval Silence-profiilina

CLASSIC 0,5	
Profiili kõrgus	32 mm
Kasulik laius	475 mm
Profiili laius	510 mm
Max pikkus	12 500 mm
Min pikkus	1200 mm
Min kalle	8°
Materjali paksus	0,5 mm
Tsingikiht	275 g/m <sup>2</sup>
Kaal	5,2 kg/m <sup>2</sup>

- ✓ Tagasipainutatud räästaserv
- ✓ Tuisukork
- ✓ Mikroprofileering kinnituskohtades
- ✓ Lisatasu eest võimalik tellida ka AnySide
- ✓ Saadaval Silence-profiilina

\*\*\* Eritellimusel, tarneaeg ja hind tuleb tellimise eel täpsustada.

\*\*\*\* Saadaval ainult Classic M 0,5 mm.

VAATA CLASSIC-PROFIILIDE VÕRDLUSTABELIT LK 8

## CLASSIC DESIGN

**NB!** Alla 20 m<sup>2</sup> tellimisel lisandub toote hinnale tootmise stardimaks 30 € (km-ta).  
Katuseprofiilid toodetakse igale kliendile eraldi vastavalt konkreetse katuse projektile.  
Kliendi spetsifikatsiooni alusel tellitud kaupa pole võimalik tagastada.

Hind €/m<sup>2</sup> 24% km-ga (€/m<sup>2</sup> km-ta)

Toote nimi		Ruukki® 50 Plus
Classic Design 271 0,6	SR35-271C	33,91 (27,35)
<b>UUS!</b> Classic Design 355 0,6	SR35-355C	36,95 (29,80)
Classic Design 475 0,6	SR35-475C	26,66 (21,50)

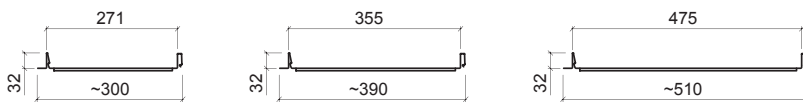
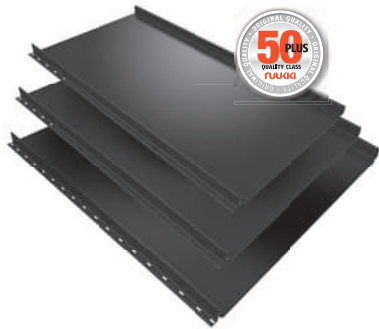

### CLASSIC DESIGN (0,6)

Profiili kõrgus	32 mm
Kasulik laius	271/355/475 mm
Profiili laius	300/390/510 mm
Max pikkus	10500 mm
Min pikkus	1200 mm
Min kalle	8°
Materjali paksus	0,6 mm
Tsingikiht	275 g/m <sup>2</sup>
Kaal	7,4; 6,7; 6,2 kg/m <sup>2</sup>

- ✓ Tagasipainutatud räätaserv
- ✓ Tuisukork
- ✓ Mikroprofileering kinnituskohdades

## VALTSPROFIILID

**NB!** Alla 20 m<sup>2</sup> tellimisel lisandub toote hinnale tootmise stardimaks 30 € (km-ta).  
Katuseprofiilid toodetakse igale kliendile eraldi vastavalt konkreetse katuse projektile.  
Kliendi spetsifikatsiooni alusel tellitud kaupa pole võimalik tagastada.

Hind €/m<sup>2</sup> 24% km-ga (€/m<sup>2</sup> km-ta)

Toote nimi		Ruukki® 50 Plus
Valtsprofiil 0,6	SR27-540A	25,42 (20,50)
Valtsprofiil 0,5	SR27-543A	20,46 (16,50)



### VALTSPROFIIL

Profiili kõrgus	27 mm
Kasulik laius	543 mm
Profiili laius	556 mm
Max pikkus	10500 mm
Min pikkus	1100 mm
Min kalle	5°
Materjali paksus	0,6/0,5 mm
Tsingikiht	275 g/m <sup>2</sup>
Kaal	4,5 kg/m <sup>2</sup>

Tänu oma spetsiifilisele lamedale tasapinnale ja terase soojuspaisumisomadustele on Classic- ja valtsprofiilidel loomulik kalduvus katusel kergelt lainetada. Seda omadust ei saa käsitleda toote defektina, kuid profiili paigaldamine vastavalt juhendis toodud soovitudele võib seda oluliselt vähendada. Plaatide ulatuses tohib tasapinnaline kõrguste erinevus olla mitte rohkem kui 1% paani laiuusest - standard EVS 920-2:2013 „Katuseehitusreeglid. Osa2 – Metallkatused“, punkt 6.8.

VAATA CLASSIC-PROFIILIDE VÕRDLUSTABELIT LK 8

## KIVIPROFIILID

**NB!** Alla 20 m<sup>2</sup> tellimisel lisandub toote hinnale tootmise stardimaks 30 € (km-ta). Ruukki katuseprofiilid toodetakse igale kliendile eraldi vastavalt konkreetse katuse projektile. Kliendi spetsifikatsiooni alusel tellitud kaupa pole võimalik tagastada.

Hind €/m<sup>2</sup> 24% km-ga (€/m<sup>2</sup> km-ta)

Toote nimi		Ruukki® 50 Plus	Ruukki® 40 matt	Ruukki® 30
Teraskivi FEB Forma®	TS44-350-1100	18,85 (15,20)		
Teraskivi	TS39-350-1100			14,26 (11,50)
Adamante	TS55-350-1130	19,96 (16,10)	17,48 (14,10)	

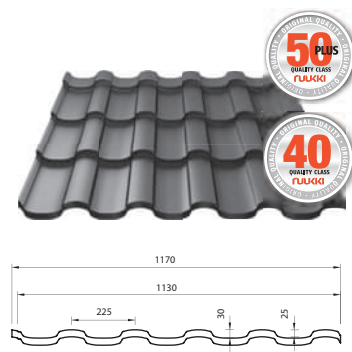
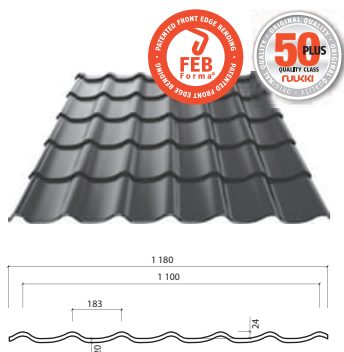

TERASKIVI FEB Forma®	
Profiili kõrgus	44 mm
Kivimustri samm	350 mm
Kasulik laius	1100 mm
Profiili laius	1180 mm
Max pikkus	8000 mm
Min pikkus	800 mm
Min kalle	14°
Materjali paksus	0,5 mm
Tsingikiht	275 g/m <sup>2</sup>
Kaal	4,7 kg/m <sup>2</sup>

TERASKIVI	
Profiili kõrgus	39 mm
Kivimustri samm	350 mm
Kasulik laius	1100 mm
Profiili laius	1180 mm
Max pikkus	8000 mm
Min pikkus	800 mm
Min kalle	14°
Materjali paksus	0,5 mm
Tsingikiht	275 g/m <sup>2</sup>
Kaal	4,7 kg/m <sup>2</sup>

ADAMANTE	
Profiili kõrgus	55 mm
Kivimustri samm	350 mm
Kasulik laius	1130 mm
Profiili laius	1170 mm
Max pikkus	8200 mm
Min pikkus	800 mm
Min kalle	14°
Materjali paksus	0,5 mm
Tsingikiht	275 g/m <sup>2</sup>
Kaal	4,8 kg/m <sup>2</sup>

FEB Forma® tagasipööratud  
räästavalts – korrosioonikindlam  
ja vastupidavam katuse.



## TRAPETSPROFIILID

**NB!** Alla 20 m<sup>2</sup> tellimisel lisandub toote hinnale tootmise stardimaks 30 € (km-ta). Ruukki katuseprofiilid toodetakse igale kliendile eraldi vastavalt konkreetse katuse projektile. Kliendi spetsifikatsiooni alusel tellitud kaupa pole võimalik tagastada.

Hind €/m<sup>2</sup> 24% km-ga (€/m<sup>2</sup> km-ta)

Toote nimi		Ruukki® 50 Plus	Ruukki® 30
Trapetsprofiil T20	T20-24W-1100	18,35 (14,80)	12,59 (10,15)
Trapetsprofiil T45	T45-30W-905		17,05 (13,75)
Trapetsprofiil T20 Anticon*	T20-24W-1100	22,63 (18,25)	18,10 (14,60)
Trapetsprofiil T45 Anticon*	T45-30W-905		21,20 (17,10)

\* Anticon: ainulaadne membraanidega antikondensaatkangas kleebitakse trapetsprofiilide T20 ja T45 alla tehases. Tehases kanga liimimine tagab kvaliteetse nakke.

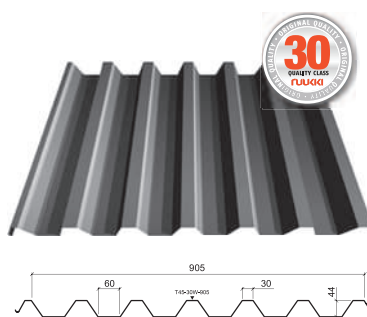
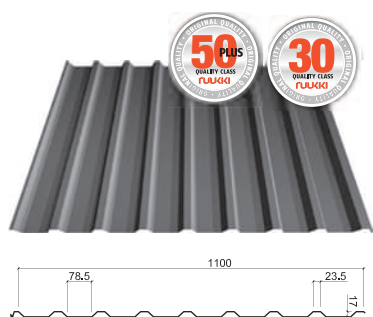

Skaneeri kood ja vaata lisainfot Anticoni kohta.

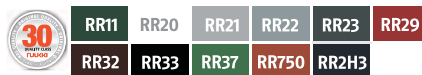

### Trapetsprofiil T20

Profiili kõrgus	17 mm
Harja laius	24 mm
Kasulik laius	1100 mm
Profiili laius	1140 mm
Max pikkus	12000 mm
Min pikkus	500 mm
Min kalle	11°
Materjali paksus	0,5 mm
Tsingikiht	275 g/m <sup>2</sup>
Kaal	4,5 kg/m <sup>2</sup>

### Trapetsprofiil T45

Profiili kõrgus	44 mm
Harja laius	30 mm
Kasulik laius	905 mm
Profiili laius	960 mm
Max pikkus	13000 mm
Min pikkus	500 mm
Min kalle	8°
Materjali paksus	0,5 mm
Tsingikiht	275 g/m <sup>2</sup>
Kaal	5,42 kg/m <sup>2</sup>

# CLASSIC-PROFIILIDE VÕRDJUSTABEL



	Classic	Classic	Classic Design	Classic Authentic
	 C	 C		 C
		 M		 M
				
<b>Kvaliteediklass</b>	<b>Ruukki® 40</b>	<b>Ruukki® 50 Plus®</b>	<b>Ruukki® 50 Plus</b>	<b>Ruukki® 50 Plus</b>
UV-taluvus				
Kriimustuskindlus				
Pinnaviimistlus	matt	matt	matt	matt
Garantii (tehniline/esteetiline)	40/15 aastat	50/25 aastat	50/25 aastat	50/25 aastat
Tagasipainutatud räästaserv 				
Tuisukork 				
Mikroprofileering kinnituskohdades 				
AnySide – võimaldab paigaldada profiili mõlemas suunas (eeltellimusel) 				
Materjali paksus  0,6 mm				
Mikroprofileering profiilil 				
Tehases paigaldatud heliisolatsioonimaterjal  <b>UUS!</b>				
	lisavõimalusena	lisavõimalusena		lisavõimalusena

## KATUSEPROFIILIDE VÄRVITOONID

	 Kvaliteedi- klass	Materjali paksus (mm)	Pinnaviimistlus	Okkaroheline RR11	Valge RR20	Helehall RR21	Hall RR22	Tumehall RR23	Punane RR29	Tumepruun RR32	Must RR33	Roheline RR37	Kivipunane RR750	Sokoladipruun RR887	Antratsiithall RR2H3
--	---	-----------------------	-----------------	----------------------	---------------	------------------	--------------	------------------	----------------	-------------------	--------------	------------------	---------------------	------------------------	-------------------------

### CLASSIC- JA VALTSPROFIILID

Classic Authentic	Ruukki® 50 Plus	0,6	matt	●*		●*	●*	●	●*	●	●		●*		●
Classic Design	Ruukki® 50 Plus	0,6	matt					●			●				●
Classic M	Ruukki® 50 Plus	0,5	matt	●		●*	●	●	●	●	●		●	●	●
	Ruukki® 50 Plus	0,6	matt	●		●*	●	●	●	●	●		●		●
Classic	Ruukki® 50 Plus	0,5	matt	●			●	●	●	●	●		●	●	●
	Ruukki® 40 matt	0,5	matt					●	●	●	●			●	●
Valtsprofiil	Ruukki® 50 Plus	0,5	matt	●			●	●	●	●	●		●	●	
Valtsprofiil*	Ruukki® 50 Plus	0,6	matt	●		●	●	●	●	●	●		●		●

\* Tarneaeg tuleb tellimise eel täpsustada

### KIVIPROFIILID

Adamante	Ruukki® 50 Plus	0,5	matt	●				●	●	●	●		●	●	●
	Ruukki® 40	0,5	matt					●	●	●	●			●	●
Teraskivi FEB Forma	Ruukki® 50 Plus	0,5	matt	●		●	●	●	●	●	●		●	●	●
Teraskivi	Ruukki® 30	0,5	läikiv	●				●	●	●	●		●	●	●

### TRAPETSPROFIILID



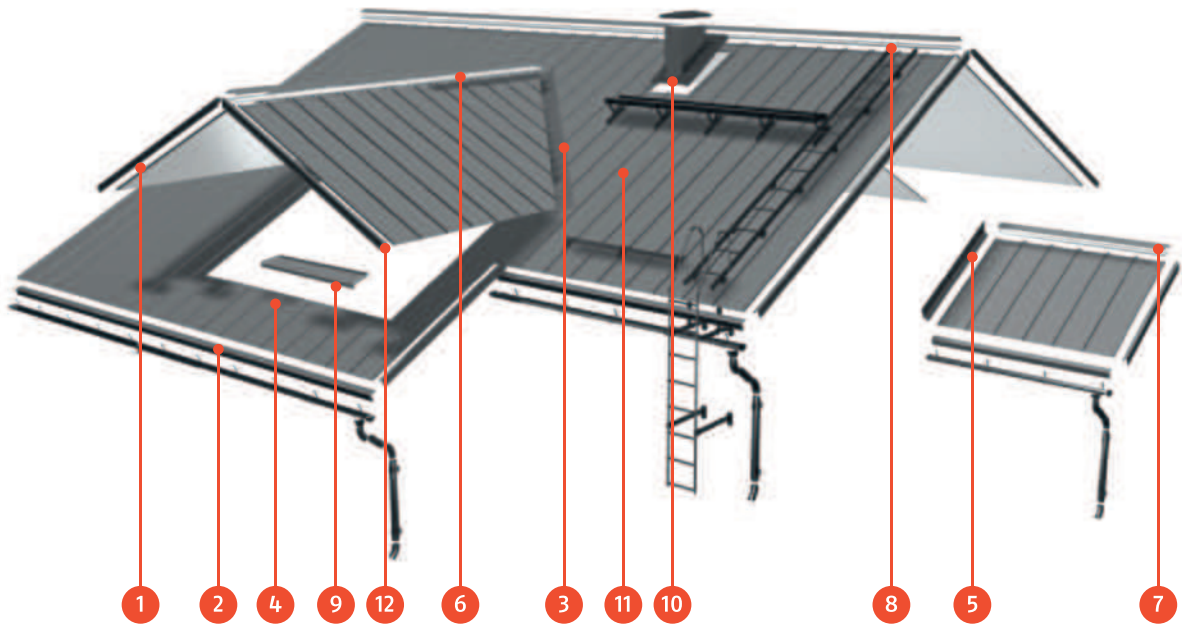

T20	Ruukki® 50 Plus	0,5	matt	●		●	●	●	●	●	●		●	●	●
	Ruukki® 30	0,5	läikiv	●	●	●	●	●	●	●	●	●	●		
T45	Ruukki® 30	0,5	läikiv	●	●	●	●	●	●	●	●	●	●		



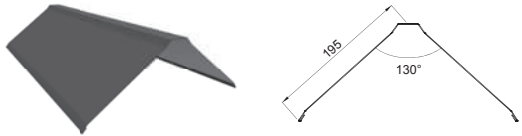
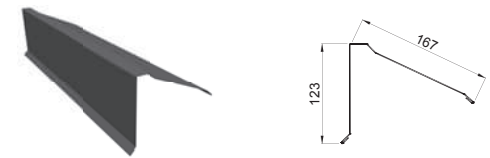

## LISAPLEKID CLASSIC- JA VALTSPROFIILIDELE

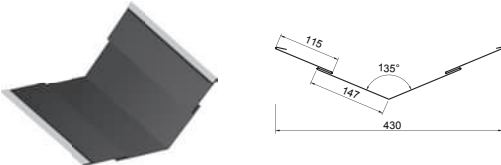
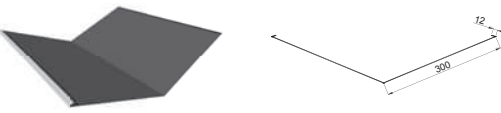

- |                    |                        |                            |
|--------------------|------------------------|----------------------------|
| 1 Otsaplekk        | 5 Liiteplekk, Classic  | 9 Aknaplekk                |
| 2 Räästaplekk      | 6 Harjaplekk           | 10 Liiteplekk              |
| 3 Neelupõhjaaplekk | 7 Räästaplekk, ülemine | 11 Jätakuplekk             |
| 4 Liiteplekk       | 8 Harjatihendusplekk   | 12 Otsapleki kork, Classic |

Hind €/tk 24% km-ga (€/tk km-ta)

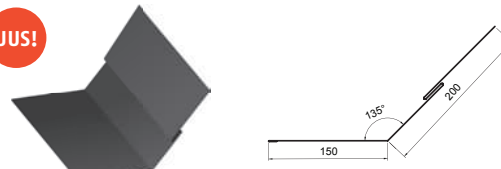
Pilt	Toote nimi	Info	Hind
	<b>Harjaplekk, sile</b>		
	L = 2000 mm	Ruukki® 50 Plus	22,32 (18,00)
		Ruukki® 40 matt	21,58 (17,40)
	<b>Räästaplekk, ülemine</b>		
	L = 2000 mm	Ruukki® 50 Plus	24,55 (19,80)
		Ruukki® 40 matt	23,87 (19,25)
	<b>Räästaplekk, kohandatav, Classic</b>		
	L = 2000 mm	Ruukki® 50 Plus	18,23 (14,70)
	<b>Otsaplekk, Classic</b>		
	L = 2000 mm	Ruukki® 50 Plus	21,27 (17,15)
		Ruukki® 40 matt	20,52 (16,55)
	<b>Otsaplekk kruvideta, Classic</b>		
	L = 2400 mm	Ruukki® 50 Plus	44,27 (35,70)
	<b>Otsapleki kork, Classic</b>		
		Ruukki® 50 Plus 0,5 mm	
		RR23 komplekt (vasak/parem)	8,25 (6,65)
		RR2H3 komplekt (vasak/parem)	8,25 (6,65)
		RR32 komplekt (vasak/parem)	8,25 (6,65)
		RR33 komplekt (vasak/parem)	8,25 (6,65)

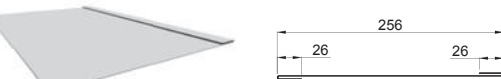
Pilt	Toote nimi	Info	Hind
	<b>Neelupõhjaplekk, kruvideta paigaldus</b>	Ruukki® 50 Plus	44,52 (35,90)
		Ruukki® 40 matt	42,53 (34,30)
L = 2000 mm			
	<b>Neelupõhjaplekk</b>	Ruukki® 50 Plus	37,57 (30,30)
	Ruukki® 40 matt	35,59 (28,70)	
L = 2000 mm			
	<b>Harjatihendusplekk, Classic</b>	Ruukki® 50 Plus, RR2H3, L = 255 mm	1,86 (1,50)
		Ruukki® 50 Plus, RR2H3, L = 340 mm	2,54 (2,05)
		Ruukki® 50 Plus, RR23, L = 460 mm	3,29 (2,65)
		Ruukki® 50 Plus L = 1410 mm	9,92 (8,00)
		Ruukki® 50 Plus, RR23, L = 3000 mm	20,46 (16,50)
	<b>Harjatihendusplekk, valtsprofiilile 0,6 mm</b>	Ruukki® 50 Plus L = 1614 mm	11,90 (9,60)
	<b>Liiteplekk Classic, kruvideta paigaldus</b>	Ruukki® 50 Plus	29,76 (24,00)
		Ruukki® 40 matt	28,40 (22,90)
L = 2000 mm			
	<b>Liiteplekk</b>	Ruukki® 50 Plus	23,44 (18,90)
		Ruukki® 40 matt	22,69 (18,30)
L = 2000 mm			
	<b>Liiteplekk, Classic</b>	Ruukki® 50 Plus	25,92 (20,90)
		Ruukki® 40 matt	23,31 (18,80)
L = 2000 mm			
	<b>Jätkuplekk, Classic</b>	L = 255 mm, RR33	3,10 (2,50)
		L = 340 mm, RR33	3,16 (2,55)
		L = 440 mm, RR33	3,79 (3,06)

## LISAPLEKID KIVI- JA TRAPETSPROFIILIDELE

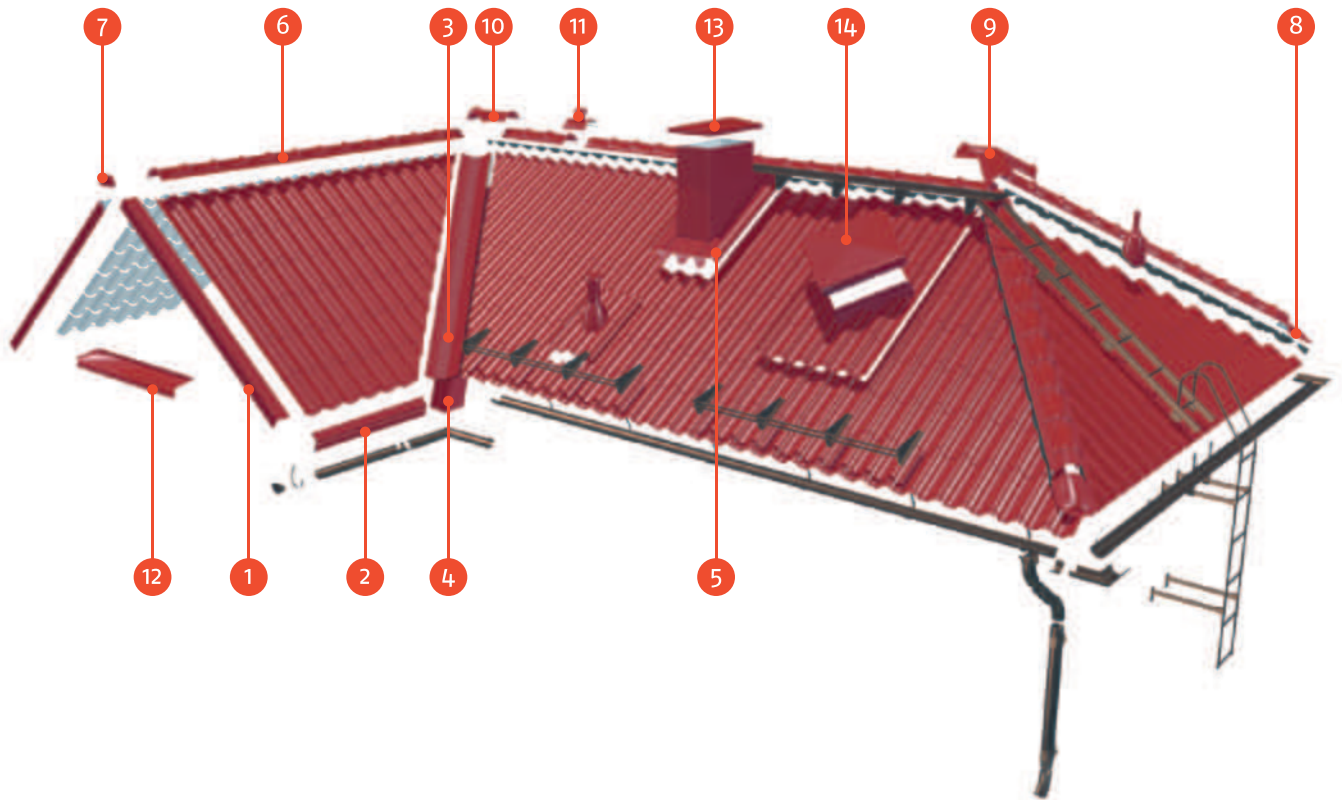

- |                   |                                      |                       |
|-------------------|--------------------------------------|-----------------------|
| 1 Otsaplekk       | 6 Harjaplekk, kumer                  |                       |
| 2 Räästaplekk     | 7 Kumera harjapleki ots              | 11 Harja tuulutustoru |
| 3 Neelukatteplekk | 8 Kumera harjapleki ots kelpkatusele | 12 Aknaplekk          |
| 4 Neelupõhjaplekk | 9 Y-liide kelpkatusele, kumer        | 13 Korstnamüts        |
| 5 Liiteplekk      | 10 T-liide kelpkatusele, kumer       | 14 Katuseluuk         |

Hind €/tk 24% km-ga (€/tk km-ta)





Pilt	Toote nimi	Info	Hind
	<b>Harjaplekk, sile</b> Teraskivi FEB Forma, Teraskivi, T20, Adamante L = 2000 mm	Ruukki® 50 Plus Ruukki® 40 matt Ruukki® 30	22,32 (18,00) 21,58 (17,40) 21,20 (17,10)
	<b>Harjaplekk, kumer</b> Teraskivi FEB Forma, Teraskivi, T20, Adamante L = 2100 mm	Ruukki® 50 Plus Ruukki® 30	26,90 (21,70) 25,30 (20,50)

## LISAPLEKID KIVI- JA TRAPETSPROFIILIDELE

Hind €/tk 24% km-ga (€/tk km-ta)

Pilt	Toote nimi	Info	Hind
	<b>Räästaplekk, ülemine</b> Teraskivi FEB Forma, Teraskivi, T20, Adamante L = 2000 mm	Ruukki® 50 Plus	24,55 (19,80)
		Ruukki® 40 matt	23,87 (19,25)
	<b>Otsaplekk, profiil</b> L = 2000 mm	Ruukki® 50 Plus	21,20 (17,10)
		Ruukki® 30	20,09 (16,20)
	<b>Otsaplekk, profiil (sile)</b> L = 2000 mm	Ruukki® 50 Plus	21,20 (17,10)
		Ruukki® 40 matt	20,46 (16,50)
	<b>Liiteplekk</b> Teraskivi FEB Forma, Teraskivi, T20, Adamante L = 2000 mm	Ruukki® 50 Plus	23,44 (18,90)
		Ruukki® 40 matt	22,69 (18,30)
	<b>Räästaplekk, kohandatav</b> Teraskivi FEB Forma, Teraskivi, T20, Adamante L = 2000 mm	Ruukki® 50 Plus	18,10 (14,60)
		Ruukki® 30	17,24 (13,90)
	<b>Neelupõhjaplekk</b> Teraskivi FEB Forma, Teraskivi, T20, Adamante L = 2000 mm	Ruukki® 50 Plus	37,57 (30,30)
		Ruukki® 40 matt	35,59 (28,70)
	<b>Neelukatteplekk</b> Teraskivi FEB Forma, Teraskivi, T20, Adamante L = 2000 mm	Ruukki® 50 Plus	27,83 (22,44)
		Ruukki® 40 matt	27,53 (22,20)
	<b>Sisenurgaplekk seinale</b> Teraskivi FEB Forma, Teraskivi, T20, Adamante L = 2000 mm	Ruukki® 50 Plus	36,58 (29,50)
		Ruukki® 40 matt	21,45 (17,30)
	<b>Sisenurgaplekk seinale</b> Teraskivi FEB Forma, Teraskivi, T20, Adamante L = 2000 mm	Ruukki® 30	20,58 (16,60)

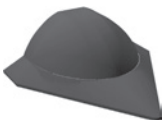





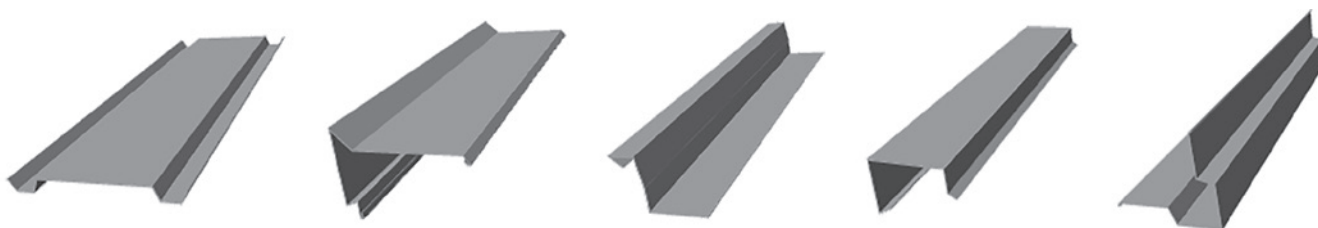

Hind €/tk 24% km-ga (€/tk km-ta)

Pilt	Toote nimi	Info	Hind
	<b>Välisnurgaplekk seinale</b>	Ruukki® 50 Plus	36,58 (29,50)
	Teraskivi FEB Forma, Teraskivi, T20, Adamante	Ruukki® 40 matt	21,45 (17,30)
	L = 2000 mm	Ruukki® 30	20,58 (16,60)
	<b>Kumera harjapleki ots</b>	plastik	5,33 (4,30)
	<b>Kumera harjapleki ots kelpkatusele</b>	plastik	15,81 (12,75)
	<b>Y-liide kelpkatusele, kumer</b>	plastik	32,34 (26,00)
	<b>T-liide kelpkatusele, kumer</b>	plastik	41,91 (33,80)
	Teraskivi FEB Forma, Teraskivi, T20, Adamante		

**Kliendi esitatud joonise kohaselt valmistatakse mittestandardseid, kuni 8 m pikkuseid lisaplekke, korstna viimistlusdetalle, erinevaid luuke, aknaplekke ja aknapiirdeid.**









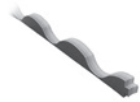

## KRUVID, TIHENDID, ALUSKATTED, TARVIKUD, PARANDUSVÄRVID

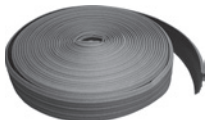
KRUVID JA TARVIKUD			Hind €/tk 24% km-ga (€/tk km-ta)	
Pilt	Toote nimi	Info	Kogus	Hind
	<b>Katusekrugi Ruukki LP Torx</b> 4,8 x 28 mm	värviline, kruvi sobib kasutada ka plekiliitekruvina, pakis otsik Torx 18	100 tk	13,64 (11,00)
	4,8 x 28 mm	värviline	100 tk	9,50 (7,66)
		tsingitud	100 tk	8,93 (7,20)
	4,8 x 23 mm	värviline	100 tk	9,50 (7,66)
		tsingitud	100 tk	8,93 (7,20)
	4,2 x 25 mm	puitroov	100 tk	7,94 (6,40)
		terasroov	100 tk	11,04 (8,90)
	<b>Katuseroovi reguleerimiskruvi</b>	140 mm	100 tk	173,60 (140,00)
		170 mm	100 tk	198,40 (160,00)
	<b>Katuseroovi abifiksaator</b>		tk	6,20 (5,00)
	<b>Kruvi katuseroovi abifiksaatorile</b>	8 x 60 mm	1 tk	0,62 (0,50)
	<b>Kruvi valtsiklambrile/ räästaplekile</b>	5,2 x 25 mm, Duracoat	1 tk	0,10 (0,08)

**TIHENDID**

Hind €/tk 24% km-ga (€/tk km-ta)

Pilt	Toote nimi	Info	Kogus	Hind
	<b>Harjatihend, universaalne, Ruukki Roll Super</b>	5 m rullis	tk	42,16 (34,00)
	<b>Harjatihend</b>	Adamante L = 1125 mm	tk	2,23 (1,80)
		Finnera L = 1140 mm	tk	2,23 (1,80)
		Teraskivi L = 1100 mm	tk	2,23 (1,80)
		T20 L = 1100 mm	tk	2,23 (1,80)
	<b>Tihend, universaalne</b>	H = 50 mm	m	2,23 (1,80)
	<b>Heliisolatsioonitihend, Classic</b>	50 m rullis	tk	35,46 (28,60)
	<b>Kleebitav heliisolatsioonitihend, Classic</b>	20 m rullis	tk	17,11 (13,80)
	<b>Tihend, pikivuugi 3 x 10 mm</b>	25 m rullis	tk	7,25 (5,75)
	<b>Butüüllint Ruukki BUTYL BAND PRO 45 mm</b>	20 m rullis	tk	25,11 (20,25)
	<b>Distantliistu tihenduslint Permo absorber 50 mm</b>	30 m rullis	tk	37,32 (30,10)
	<b>Korstnatihenduslint Ruukki FLEXO 300 mm</b>	Universaalne tihenduslint, alumiiniumist kattega. Kasutuskohad: korstna, neelu, katuseakna ümbrus. Värvid: punane, tumepruun, tumehall, ja must.	tk 300 mm x 5 m	62,00 (50,00)



## ALUSKATTED JA TARVIKUD

Hind €/tk 24% km-ga (€/tk km-ta)

Pilt	Toote nimi	Info	Hind
	Ruukki® 50 Plus aluskate, mittehingav	1,5 x 40 m, 60 m <sup>2</sup>	117,80 (95,00)
	Ruukki® 50 Plus aluskate, mittehingav	1,5 x 20 m, 30 m <sup>2</sup>	74,40 (60,00)
	Ruukki® 30 aluskate, mittehingav	1,5 x 40 m, 60 m <sup>2</sup>	67,70 (54,60)
	Aluskate Ruukki 175 FIX, hingav, kahe teibiga	1,5 x 50 m, 75 m <sup>2</sup>	205,84 (166,00)
	Aluskate Ruukki 175 FIX, hingav, kahe teibiga	1,5 x 20 m, 30 m <sup>2</sup>	105,40 (85,00)
	Aluskate Ruukki 145 FIX, hingav, kahe teibiga	1,5 x 50 m, 75 m <sup>2</sup>	125,24 (101,00)
	Aluskate Ruukki 145 FIX, hingav, kahe teibiga	1,5 x 20 m, 30 m <sup>2</sup>	69,44 (56,00)
	Aluskate Permo® sec SK, hingav, kahe teibiga	1,5 x 25 m, 37,5 m <sup>2</sup> valtskatusele	401,76 (324,00)
	Aluskate Permo® sec 400 SK, hingav, kahe teibiga	1,5 x 25 m, 37,5 m <sup>2</sup> valtskatusele	343,48 (277,00)
	Tuulutav roov	Materjali paksus 0,7 mm, L = 3700 mm H = 32 mm	11,28 (9,10)
	Aluskatteteip Ruukki A+	60 mm x 25 m, aluskate ülespöõrete fikseerimiseks, aukude parandamiseks, läbipaistev.	30,26 (24,40)
	Tuulutuskork aluskattele	Ø 98 mm (7500 mm <sup>2</sup> )	7,69 (6,20)
	Putukavõrk tuulekastile	0,6 x 25 m, rull	43,40 (35,00)

## PARANDUSVÄRVID

Hind €/tk 24% km-ga (€/tk km-ta)

Pilt	Toote nimi	Info	Hind
	Parandusvärv, läikiv	24 ml	5,46 (4,40)
		100 ml	10,73 (8,65)
	Parandusvärv, matt	24 ml	8,87 (7,16)



## Värvitoonid

RR11	RR21	RR22	RR23	RR29	RR32
RR33	RR37	RR750	RR887	RR2H3	

## UUS! VENTILATSIOONITORUD JA LÄBIVIIGUD

### VENTILATSIOONITORUD

Hind €/tk 24% km-ga (€/tk km-ta)







Pilt	Toote nimi	Info	Hind
	Tuulutustoru FLOW 110P/500, soojustatud, lõdvikuga *	Ø 110 mm	145,08 (117,00)
	Ventilatsioonitoru FLOW 125P/IS/700, soojustatud	Ø 125 mm	136,40 (110,00)
	Ventilatsioonitoru FLOW 160P/IS/700, soojustatud	Ø 160 mm	245,52 (198,00)
	Ventilatsioonitoru FLOW 200P/IS/700, soojustatud **	Ø 200 mm	381,92 (308,00)
	Ventilatsioonitoru FLOW ventilaatoriga ECO 125P/700 Ei sisalda regulaatorit	Ø 125 mm	668,36 (539,00)

\* Kaasas painduv kummist ühendustoru.

\*\* Vajalik kasutada ventilatsioonitoru läbiviiku XL.

**VENTILATSIOONITORU LÄBIVIIGUD**

Hind €/tk 24% km-ga (€/tk km-ta)

Pilt	Toote nimi	Info	Hind
	Ventilatsioonitoru läbiviik Vino, Classic (kaldele 11,5-57°)	Ø 75-160 mm	89,28 (72,00)
	Ventilatsioonitoru läbiviik, Classic (kaldele 5-27°)	Ø 75-160 mm	89,90 (72,50)
	Ventilatsioonitoru läbiviik, Adamante	Ø 75-160 mm	89,90 (72,50)
	Ventilatsioonitoru läbiviik, Teraskivi	Ø 75-160 mm	89,90 (72,50)
	Ventilatsioonitoru läbiviik, universaalne *	Ø 75-160 mm Ø 160-250mm	125,24 (101,00) 148,80 (120,00)
	Ventilatsioonitoru läbiviik XL, Classic	Ø 160-250 mm	136,40 (110,00)
	Antennikaelus	Ø 12-100 mm	66,15 (53,35)

\* Paigaldada harja lähedale otsaga harjapleki alla.

**KATUSELUUGID**

Hind €/tk 24% km-ga (€/tk km-ta)

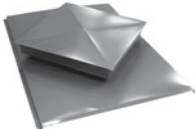
Pilt	Toote nimi	Info	Hind
	Katuseluuk Ruukki Pro	Classic (integreeritav, 800 x 600 mm, 0,6 mm)	483,60 (390,00)
	Katuseluuk, plekk	Classic (integreeritav, 800 x 600 mm) Classic (pealepandav, 800 x 600 mm) Valtsprofiil (hingede ja riiviga, 800 x 600 mm) Universaalne (kaks käepidet, 800 x 600 mm) Universaalne, ovaalne (üks käepide, 500 x 700 mm)	248,00 (200,00) 248,00 (200,00) 248,00 (200,00) 248,00 (200,00) 248,00 (200,00)

**NB!** Pilt on illustreeriv. Ruukki katuseluugid toodetakse iga tellimuse jaoks eraldi vastavalt konkreetse katuse projektile. Tellimusega tellitud kaupa pole võimalik tagastada.

**KUMMIST LÄBIVIIGUD**

Hind €/tk 24% km-ga (€/tk km-ta)

Pilt	Toote nimi	Info	Hind
	Läbiviik, kummist	Ø 6-146 mm Ø 121-254 mm	39,68 (32,00) 84,32 (68,00)
	Läbiviik, kummist, nõõbitav	Ø 12-102 mm	39,68 (32,00)

## UUS! VIHMAVEESÜSTEEM SIBA TECH

Innovaatiline kombinatsioon ümarast ja kandilisest vihmaveerennist

- 13% suurem tõhusus
- pinnakate GreenCoat RWS Pro
- valmistatud 0,6 mm SSAB terasest

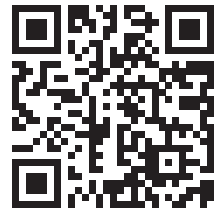

Skaneeri kood,  
vaata videot ja  
tutvuge kõigi Siba  
Techi eelistega!

### Üks renn, kaks valikut

kandiline esiosa →  ← ümar esiosa



#### Ümara esiosaga

- 1 Vihmaveerenn
- 2 Välimine nurk 90°, ümar
- 3 Sisemine nurk 90°, ümar
- 4 Rennijätk
- 5 Rennioots
- 6 Konks
- 7 Vihmaveetoru, ümar
- 8 Renni allatulek, ümar
- 9 Põlv
- 10 Suue
- 11 Toru kinnitusklamber, ümar, puit
- 12 Toru kinnitusklamber, ümar, kivi



#### Kandilise esiosaga

- 1 Vihmaveerenn
- 2 Välimine nurk 90°, kandiline
- 3 Sisemine nurk 90°, kandiline
- 4 Rennijätk
- 5 Rennioots
- 6 Konks
- 7 Vihmaveetoru, kandiline
- 8 Renni allatulek, kandiline
- 9 Põlv/suue
- 10 Toru kinnitusklamber, kandiline, puit
- 11 Toru kinnitusklamber, kandiline, kivi

#### Värvitoonid

RR23













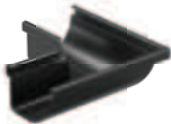







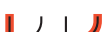

RR33



























RR887

RR2H3

**UUS!****VIHMAVEESÜSTEEM SIBA TECH**

Hind €/tk 24% km-ga (€/tk km-ta)





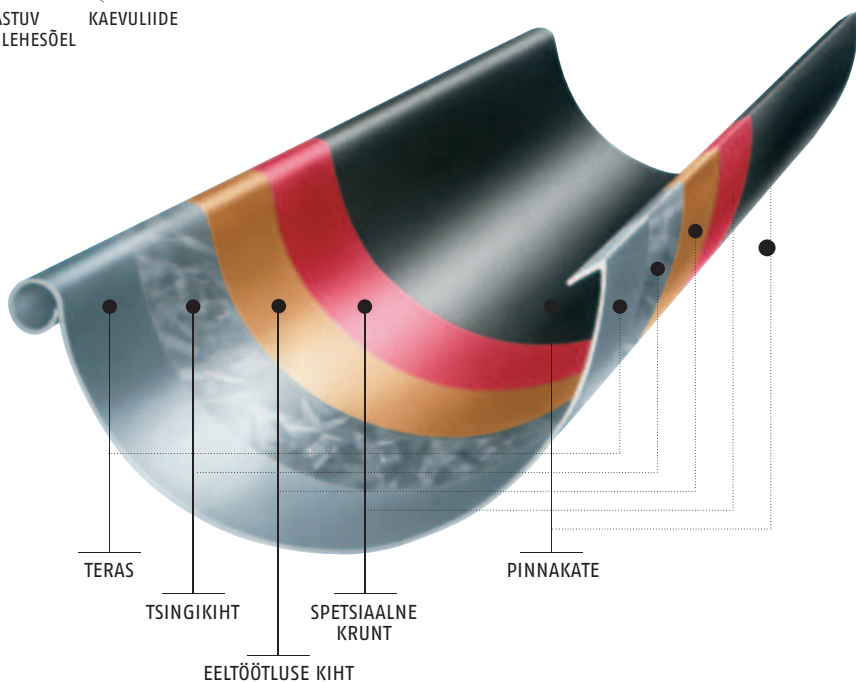
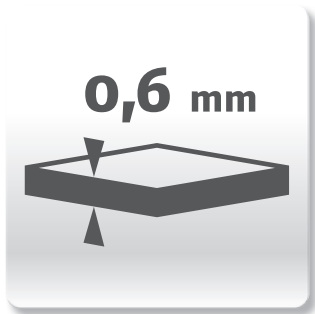

Pilt	Toote nimi	Tüüp	Info	Hind
	Vihmaveerenn 	140 mm	3000 mm	31,62 (25,50)
		140 mm	4000 mm	41,11 (33,15)
	Sisemine nurk 90°, kandiline Välimine nurk 90°, ümar 	140 mm		18,97 (15,30)
	Sisemine nurk 90°, ümar Välimine nurk 90°, kandiline 	140 mm		18,97 (15,30)
	Rennijätk 	140 mm		5,08 (4,10)
	Renniots: vasak pool kandiline, parem ümar 	140 mm		4,04 (3,26)
	Renniots: parem pool kandiline, vasak ümar 	140 mm		4,04 (3,26)
	Lühike konks, kandiline 	140 mm		7,59 (6,12)
	Compact konks, kandiline 	140 mm		5,08 (4,10)
	Pikk konks, kandiline 	140 mm		7,59 (6,12)
	Lühike konks, ümar 	140 mm		7,59 (6,12)
	Compact konks, ümar 	140 mm		5,08 (4,10)
	Pikk konks, ümar 	140 mm		7,59 (6,12)

Pilt	Toote nimi	Tüüp	Info	Hind
	<b>Vihmaveetoru, kandiline</b> 	80 x 80 mm	1000 mm	13,91 (11,22)
		80 x 80 mm	3000 mm	38,63 (31,15)
	<b>Renni allatulek, kandiline</b> 	140/80 x 80 mm		11,41 (9,20)
	<b>Pölv/suue, kandiline</b> 	80 x 80 mm		7,59 (6,12)
	<b>Toru kinnituskamber, kandiline, kivi</b> 	80 x 80 mm		3,16 (2,55)
	<b>Toru kinnituskamber, kandiline, puit</b> 	80 x 80 mm		3,16 (2,55)
	<b>Vihmaveetoru, ümar</b> 	90 mm	1000 mm	13,64 (11,00)
		90 mm	2500 mm	31,74 (25,60)
		90 mm	4000 mm	50,34 (40,6)
	<b>Renni allatulek, ümar</b> 	140/90 mm		11,41 (9,20)
	<b>Pölv, ümar</b> 	90 mm		7,51 (6,06)
	<b>Suue, ümar</b> 	90 mm		7,51 (6,06)
	<b>Toru kinnituskamber, ümar, kivi</b> 	90 mm		3,20 (2,58)
	<b>Toru kinnituskamber, ümar, puit</b> 	90 mm		3,20 (2,58)
	<b>Trapp kandilisele vihmaveetorule</b> 	80 x 80 mm, plastik		33,48 (27,00)
	<b>Trapp ümarale vihmaveetorule</b> 	Ø 75, 90, 100 mm, plastik		32,24 (26,00)

# VIHMAVEESÜSTEEM, ÜMAR













## VIHMAVEESÜSTEEM, ÜMAR

VIHMAVEERENN JA TARVIKUD (ÜMAR)				Hind €/tk 24% km-ga (€/tk km-ta)	
Pilt	Toote nimi	Tüüp	Info	Läikiv pinnaviimistlus (GreenCoat RWS)	Matt pinnaviimistlus (GreenCoat RWS PRO BT matt)*
	Vihmaveerenn	125 mm	3,0 m	30,13 (24,30)	33,11 (26,70)
			4,0 m	38,94 (31,40)	42,82 (34,55)
		150 mm	3,0 m	46,69 (37,65)	
			4,0 m	51,35 (41,40)	
	Välisnurk, 90°	125 mm		18,60 (15,00)	24,86 (16,50)
		150 mm		23,56 (19,00)	
	Sisenurk, 90°	125 mm		18,60 (15,00)	24,86 (16,50)
		150 mm		23,56 (19,00)	
	Sirge ülevoolukaitse		pikkus 350 mm, kõrgus kinnitist 95 mm	27,28 (22,00)	
	Nurga ülevoolukaitse		pikkus 175 + 175 mm, kõrgus kinnitist 85 mm	35,34 (28,50)	
	Rennioots, combi	125 mm	tihendiga	3,84 (3,10)	4,22 (3,40)
		150 mm	tihendiga	6,94 (5,60)	
	Rennijätk	125 mm		4,22 (3,40)	4,59 (3,70)
		150 mm		6,94 (5,60)	
	Reguleeritav rennikonks	125 mm		6,94 (5,60)	7,69 (6,20)
		150 mm		9,73 (7,85)	
	Iselukustuv rennikonks	125 mm	pikk	3,97 (3,20)	4,34 (3,50)
		125 mm	lühike	3,72 (3,00)	4,03 (3,25)
		150 mm	lühike	5,08 (4,10)	
		150 mm	pikk	5,21 (4,20)	

\* Eritellimusel

**VIHMAVEETORU JA TARVIKUD (ÜMAR)**







Hind €/tk 24% km-ga (€/tk km-ta)

Pilt	Toote nimi	Tüüp	Info	Läikiv pinnaviimistlus (GreenCoat RWS)	Matt pinnaviimistlus (GreenCoat RWS PRO BT matt)*
	<b>Rennikonks, strong</b>	125 mm		4,59 (3,70)	
	<b>Rennikonksu seadenurk, ümmargune</b>	125 mm	RR23, RR32 strong konksule	2,60 (2,10)	
	<b>Vihmaveetoru</b>	90 mm	1,0 m	13,76 (11,10)	15,00 (12,10)
		90 mm	2,5 m	31,74 (25,60)	34,97 (28,20)
		90 mm	4,0 m	50,34 (40,60)	55,37 (44,65)
		100 mm	1,0 m	15,44 (12,45)	
		100 mm	2,5 m	34,78 (28,05)	
		100 mm	4,0 m	55,80 (45,00)	
	<b>Renni allatulek</b>	125/90 mm		10,54 (8,50)	11,54 (9,31)
		125/100 mm		10,54 (8,50)	
		150/90 mm		12,90 (10,40)	
		150/100 mm		12,90 (10,40)	
	<b>Pölv</b>	90 mm	70°	6,82 (5,50)	7,56 (6,10)
		100 mm	70°	9,49 (7,65)	
	<b>Suue</b>	90 mm	70°	6,82 (5,50)	7,56 (6,10)
		100 mm	70°	9,49 (7,65)	
	<b>Toru kinnitusklamber kiiluga</b>	90 mm	puit	2,91 (2,35)	3,22 (2,60)
		100 mm	puit	3,92 (3,16)	
	<b>Toru kinnitusklamber kiiluga</b>	90 mm	kivi	2,91 (2,35)	3,22 (2,60)
		100 mm	kivi	3,92 (3,16)	
	<b>Kinnitusankur soojustatud fassaadile</b>		äärikumutter M10	0,63 (0,51)	
			jalapolt M10 x 100 mm	2,79 (2,25)	
			kinnitusankur 100 mm*	11,53 (9,30)	
			kinnitusankur 160 mm	12,40 (10,00)	
			kinnitusankur 200 mm	13,27 (10,70)	
			kinnitusankur 280 mm*	14,20 (11,45)	
	<b>Kaevuliide</b>	90 mm	vajalik lisadetail: trapiühendus	33,98 (27,40)	37,82 (30,50)
		100 mm	vajalik lisadetail: trapiühendus	59,52 (48,00)	

\* Eritellimusel



**VIHMAVEETORU JA TARVIKUD (ÜMAR)**

Hind €/tk 24% km-ga (€/tk km-ta)

Pilt	Toote nimi	Tüüp	Info	Läikiv pinnaviimistlus (GreenCoat RWS)	Matt pinnaviimistlus (GreenCoat RWS PRO BT matt)
	Sobitusrõngas vihmaveetorule	90 mm		6,08 (4,90)	
		100 mm		8,87 (7,15)	
	Y-liide	90 mm		58,28 (47,00)	63,98 (51,60)
		100 mm		61,13 (49,30)	
	Lehter	90 m		38,81 (31,30)	
		100 mm		35,39 (34,70)	
	Reguleeritav väljavooluava vihmavee kogumiseks	90 mm		50,22 (40,50)	
		100 mm		56,67 (45,70)	
	Trapiühendus, plastik	80-105 mm		3,22 (2,60)	
	Isepuhastuv trapp, plastik		kõrgus 325 mm, vajalik lisadetail: trapiühendus	20,46 (16,50)	

**VIHMAVEESÜSTEEMI LISATARVIKUD**

Hind €/tk 24% km-ga (€/tk km-ta)

Pilt	Toote nimi	Info	Hind
	Parandusvärv vihmaveesüsteemile	24 ml	5,08 (4,10)
	Tihendusmastiks vihmaveesüsteemile	elastne	11,28 (9,10)
	Neet AL/ST	3,2 x 8,0 mm 100 tk/pakk	5,83 (4,70)
	Kruvi rennikonksule	4,8 x 35 mm, RR2H3 100 tk/pakk, RR22	8,43 (6,80)
	Kruvi rennikonksu seadenurgale	4,8 x 11 mm, tsingitud 100 tk/pakk, sisaldab otsikut	4,22 (3,40)

**Värvitoonid**







RR20	RR23	RR29	RR32	RR33	RR40
RR41 *	RR750	RR887	RR2H3	Tsinkmagneesium *	Vask *

**Värvitoonid (matt)**

RR33
------

\* Tellimisel.

## VIHMAVEESÜSTEEM, PEIDETUD

VIHMAVEERENN JA TARVIKUD (PEIDETUD)		Hind €/tk 24% km-ga (€/tk km-ta)		
Pilt	Toote nimi	Tüüp	Info	Hind
	Vihmaveerenn	150 mm	2,0 m	25,92 (20,90)
		150 mm	4,0 m	51,345 (41,40)
	Allatulek	150/100 mm		12,90 (10,40)
	Peidetud rennikonks	150 mm		14,51 (11,70)
	Rennijätk, lai	150 mm	klambriga	6,51 (5,25)
	Sisenurk, 90°	150 mm		23,56 (19,00)
	Välisnurk, 90°	150 mm		23,56 (19,00)
	Renniots, combi	150 mm	tihendiga	6,94 (5,60)

**VIHMAVEERENN JA TARVIKUD (PEIDETUD)**

Hind €/tk 24% km-ga (€/tk km-ta)

Pilt	Toote nimi	Info	Hind
	<b>Eesmine katteplekk</b> L = 2400 mm	Ruukki® 50 Plus	17,61 (14,20)
	<b>Sisenurga katteplekk</b> 210 x 210 mm	Ruukki® 50 Plus	5,58 (4,50)
	<b>Välisnurga/otsa katteplekk</b> 210 x 210 mm	Ruukki® 50 Plus	5,58 (4,50)
	<b>Eesmise kattepleki alus</b> L = 2400 mm		16,74 (13,50)
	<b>Otsa kattepleki alus</b>		5,15 (4,15)
	<b>Ülemine räästaplekk</b> L = 2400 mm	Ruukki® 50 Plus	12,40 (10,00)
	<b>Alumine räästaplekk</b> L = 2400 mm	Ruukki® 50 Plus	17,98 (14,50)

**Värvitoonid**

RR22\*

RR23\*









RR2H3\*

RR33\*



\* Tellimisel.

**VIHMAVEETORU JA TARVIKUD (PEIDETUD)**

Hind €/tk 24% km-ga (€/tk km-ta)

Pilt	Toote nimi	Tüüp	Info	Hind
	PVC vihmaveetoru	110 mm	3,0 m	12,40 (10,00)
			1,0 m	8,99 (7,25)
	PVC vihmaveetoru klamber	110 mm	90 mm	2,85 (2,30)
			150 mm	4,59 (3,70)
	PVC torupõlv, 87°	110 mm		2,48 (2,00)
	PVC torupõlv, 30°	110 mm		1,92 (1,55)
	Vihmaveetoru isolatsiooniprofil		1,0 m	6,82 (5,50)
	Vihmaveetoru tihendusrõngas	110 mm		4,59 (3,70)
	Roostevaba toruklamber	110 mm		2,85 (2,30)
	Vihmavee koguja	110 mm	200 x 200 x 200 mm	37,82 (30,50)

## LUMETÖKKED, KATUSESILLAD, REDELID

KATUSESILLAD		Hind €/tk 24% km-ga (€/tk km-ta)	
Pilt	Toote nimi	Info	Hind
	Katusesild	600 mm	33,48 (27,00)
		1400 mm	74,40 (60,00)
		3000 mm	121,52 (98,00)
	Katusesilla kandur, 2 tk komplektis *	Teraskivi, Adamante	34,72 (28,00)
		T20	34,72 (28,00)
	Katusesilla kandur UniSeam, 2 tk komplektis *, **	Classic- ja Valtsprofiilid	47,12 (38,00)
	Katusesilla kalde reguleerimise plaat, 2 tk komplektis *, **	Võimaldab reguleerida kallet 5-45°	16,74 (13,50)

\* Komplekt sisaldab kõiki vajalikke kinnitustarvikuid.

\*\* Katusesilla paigaldamiseks 5-45° katustele tuleb lisaks kandurile kasutada ka katusesilla kalde reguleerimise plaati.

LUMETÖKKED		Hind €/tk 24% km-ga (€/tk km-ta)	
Pilt	Toote nimi	Info	Hind
	Lumetõkketoru	3000 mm	24,43 (19,70)
	Lumetõkkekandur, 2 tk komplektis *	Teraskivi, Adamante	34,72 (28,00)
		T20	34,72 (28,00)
	Lumetõkkekandur UniSeam, 2 tk komplektis *	Classic- ja Valtsprofiilid	47,12 (38,00)

\* Komplekt sisaldab kõiki vajalikke kinnitustarvikuid.



## REDELID

Hind €/tk 24% km-ga (€/tk km-ta)

Pilt	Toote nimi	Info	Hind
	<b>Redel SafeGrip 400</b>	1200 mm	49,48 (39,90)
		2700 mm	95,48 (77,00)
		3300 mm	117,18 (94,50)
	<b>Redeli libisemiskaitse (kinnitustarvikuteta)</b>		23,56 (19,00)
	<b>Katuseredeli kinnituskomplekt profiilkatustele</b>	Adamante, Teraskivi, T20  Üks komplekt sobib kuni 4,5 m redelile	51,46 (41,50)
	<b>Katuseredeli kinnituskomplekt UniSeam</b>	Classic ja Valtsprofiilid  Üks komplekt sobib kuni 6 m redelile	90,40 (72,90)
	<b>Katuseredeli lisajalgade paar</b>		13,45 (10,85)
	<b>Seinaredeli paigalduskomplekt</b>		172,98 (139,50)
	<b>Seinaredeli lisajalad, paar</b>	1000 mm	52,08 (42,00)
	<b>Seinaredeli ülakaare kinnitus katusesillale</b>		14,14 (11,40)
	<b>Seinaredeli ülakaare tugikaare komplekt</b>	Redelile laiuslega 400 mm	39,18 (31,60)

**REDELID**

Hind €/tk 24% km-ga (€/tk km-ta)

Pilt	Toote nimi	Info	Hind
	Evakuatsiooniredeli paigalduskomplekt		56,17 (45,30)
	Evakuatsiooniredeli lisajalgade paar		17,86 (14,40)

**Värvitoonid**

RR11	RR20	RR21	RR23	RR29
RR32	RR33	RR750	RR887	RR2H3

Võimalus tellida ka erivärve.







Toodame terasel põhinevaid tooteid seintele ja katustele, nii ärihoonetele kui ka eramutele. Tarnime kõrge kvaliteediga tooteid, süsteeme ja lahendusi, mis on välja töötatud jätkusuutlikult ja peavad vastu ka kõige karmimates tingimustes.

Üksikute toodete tellimisel lisandub kullertranspordi hind. Kõik Ruukki Products ASi hinnakirjas kuvatud pildid on illustratiivsed. Garantiitingimused on leitavad [www.ruukki.ee](http://www.ruukki.ee). Ruukki Products AS jätab endale õiguse hindu muuta ühekuulise etteteatamisega.

# RUUKKI

Ruukki Products AS, Turba 7, 80010 Pärnu  
Tel 447 9900, [www.ruukki.ee](http://www.ruukki.ee)

Copyright© 2026 Ruukki Construction. Kõik õigused kaitstud. Ruukki ja Ruukki tootenimed on SSAB tütarettevõtte Rautaruukki kaubamärgid või registreeritud kaubamärgid.

